

**Why embedded cameras
are difficult
and how to make them easy**

Embedded Linux Conference Europe 2018
Edinburgh, UK

Laurent Pinchart
laurent.pinchart@ideasonboard.com

?

Cameras are complex devices that need heavy hardware image processing operations. Control of the processing is based on advanced algorithms that must run on a programmable processor. This has traditionally been implemented in a dedicated MCU in the camera, but in embedded devices algorithms have been moved to the main CPU to save cost. Blurring the boundary between camera devices and Linux often left the user with no other option than a vendor-specific closed-source solution.

!

To address this problem the [Linux media community](#) has very recently started collaboration with the industry to develop a camera stack that will be open-source-friendly while still protecting vendor core IP. libcamera was born out of that collaboration and will offer modern camera support to Linux-based systems, including traditional Linux distributions, ChromeOS and Android.

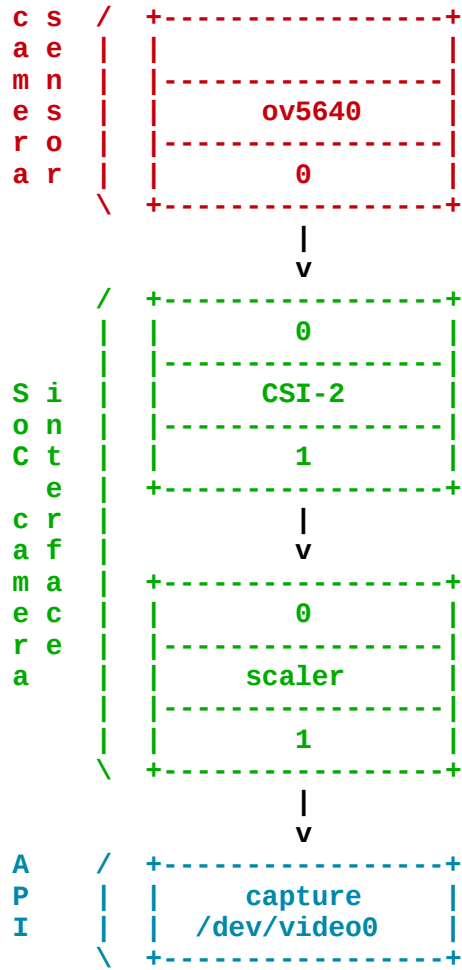

Why?

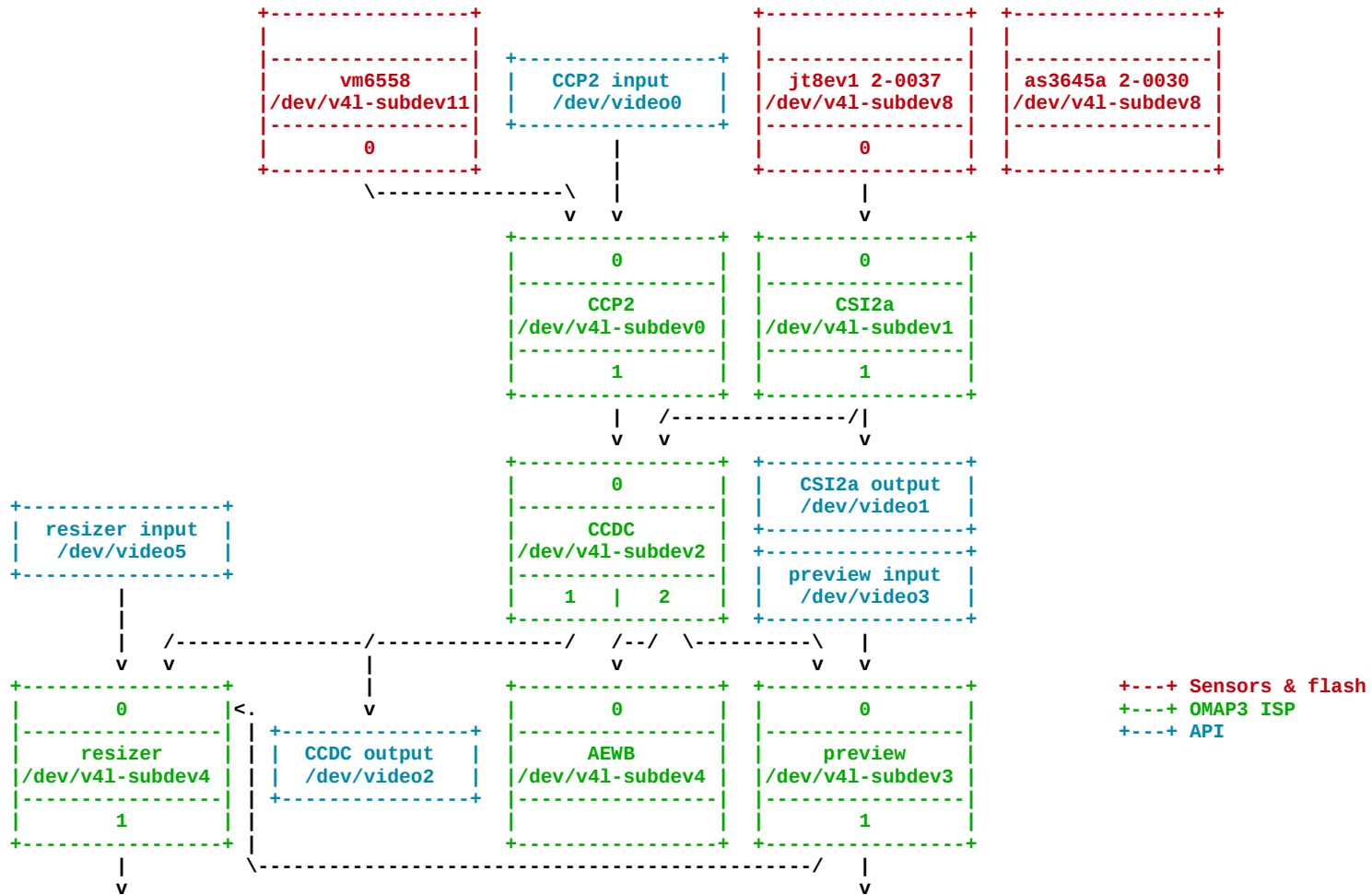

IDEAS
ON BOARD

Why?

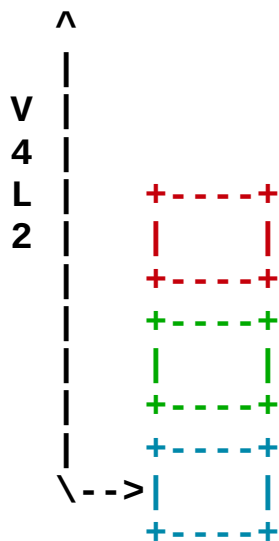

Why?

+-----+
 | Camera |
 | Application |
 +-----+

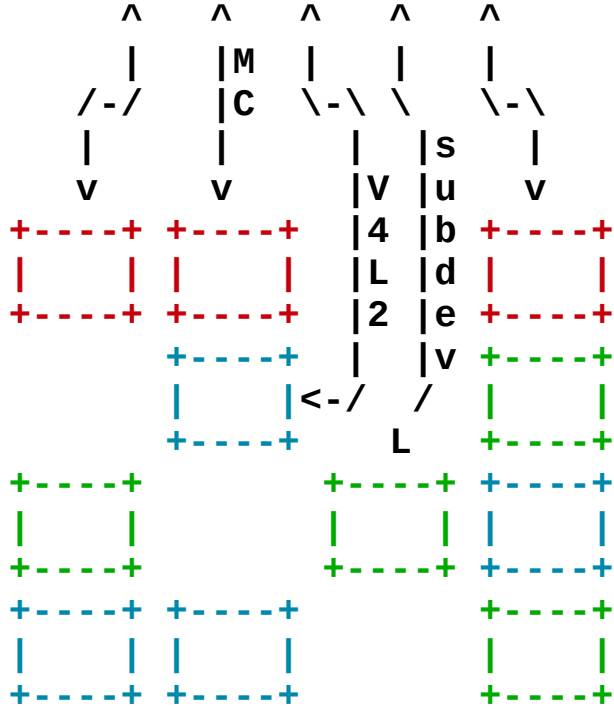

Why?

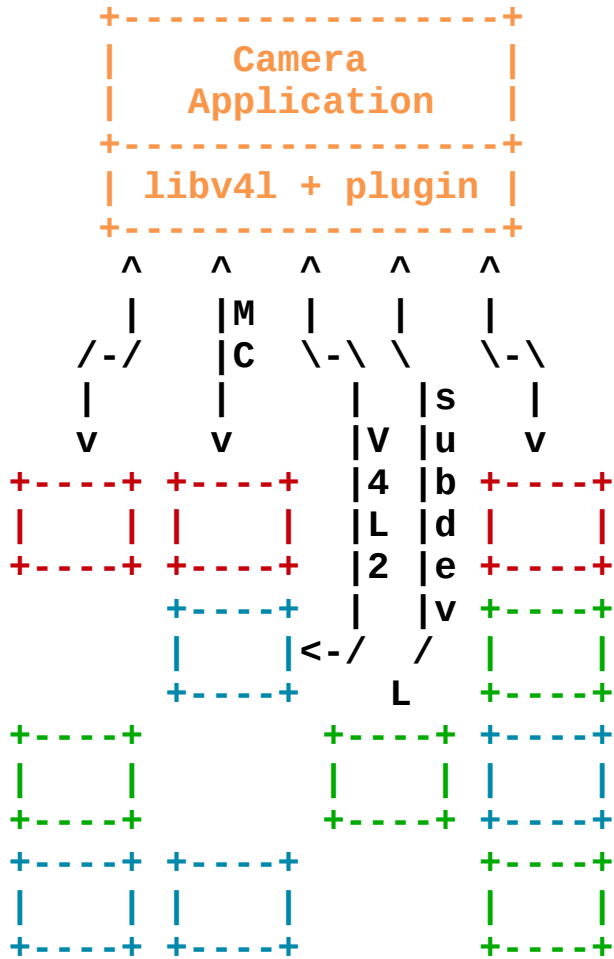

Why?

+ - / \ - +

| (o) | libcamera

+ - - - - +



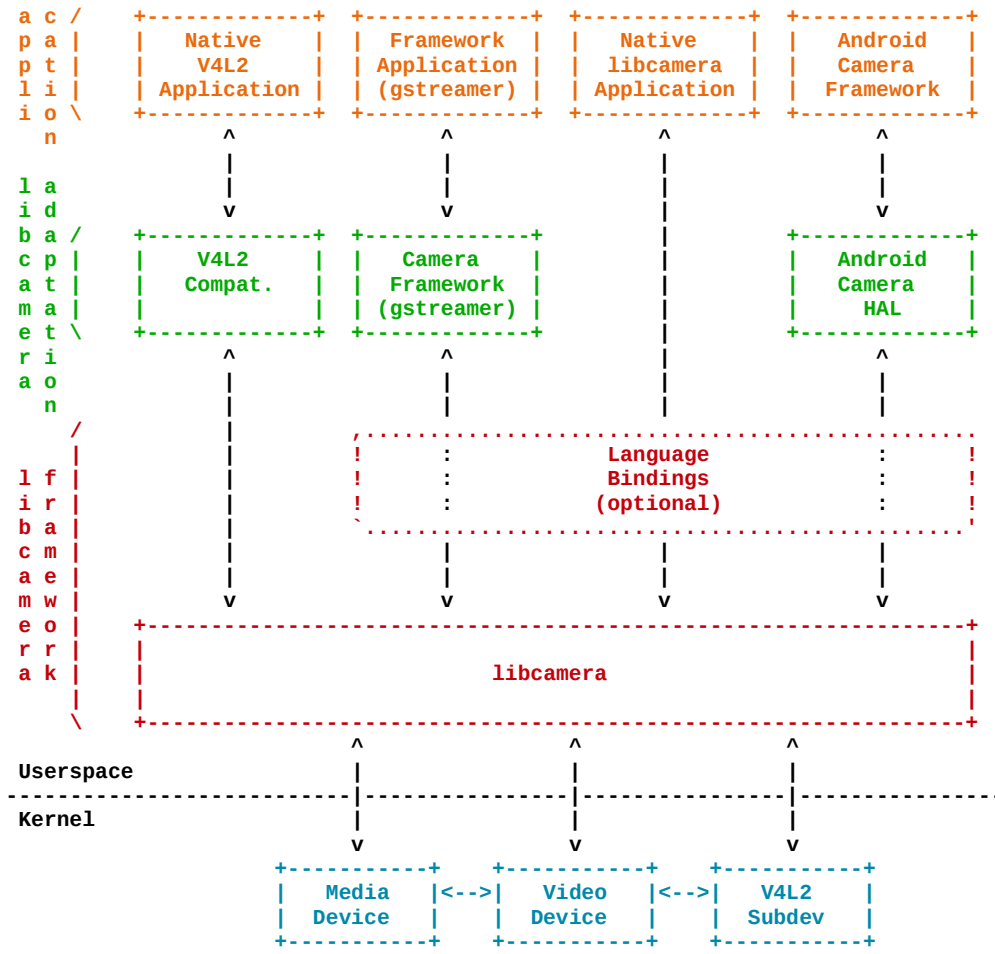

Camera Stack

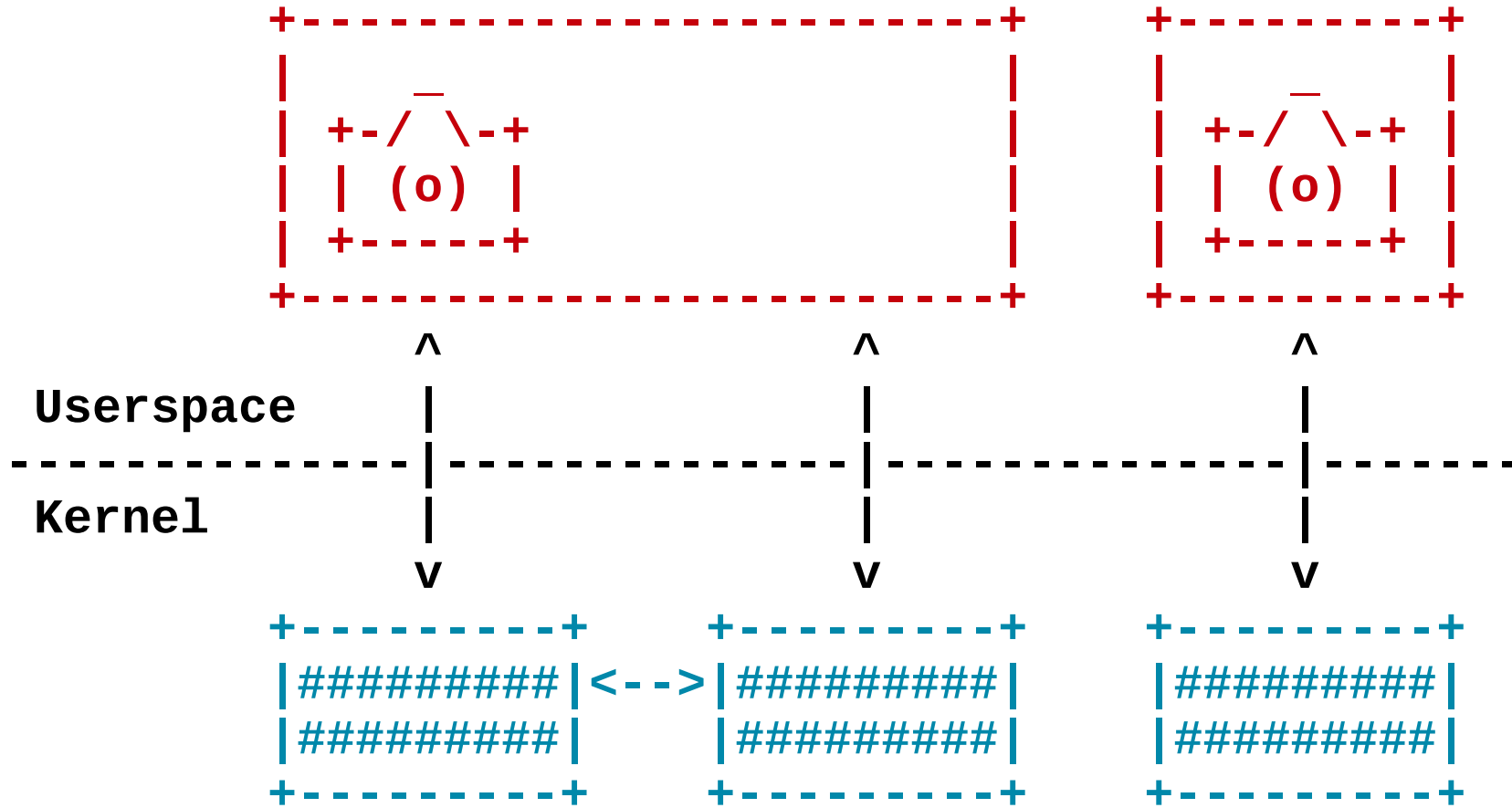

Camera Devices & Enumeration



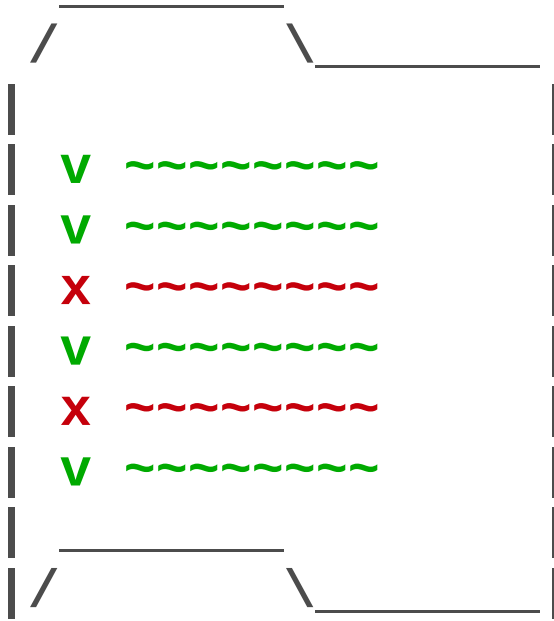

Capabilities

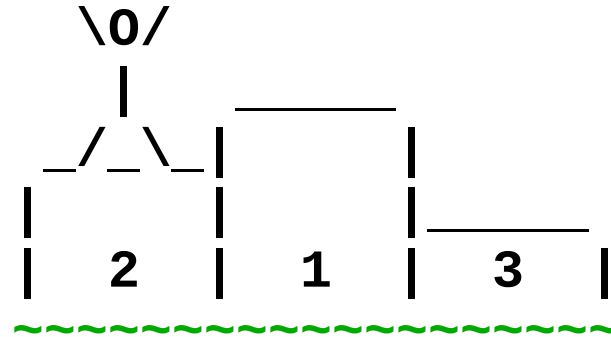

Profiles



Capabilities & Profiles

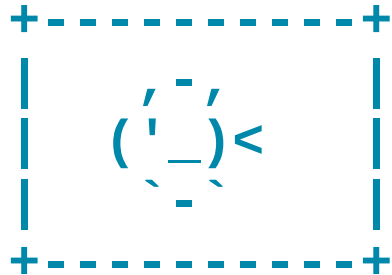
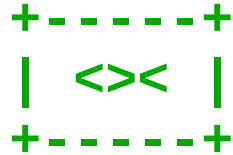
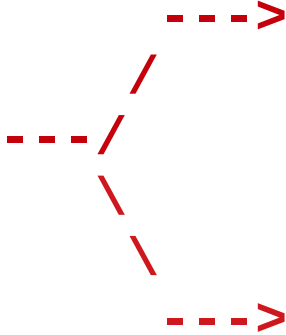
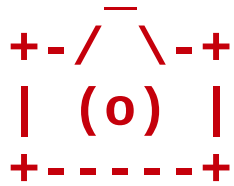

Streams

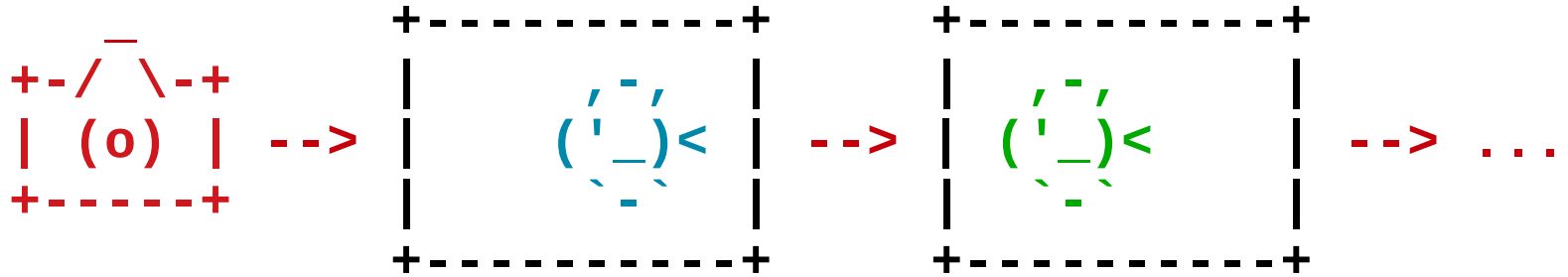

Per-Frame Controls



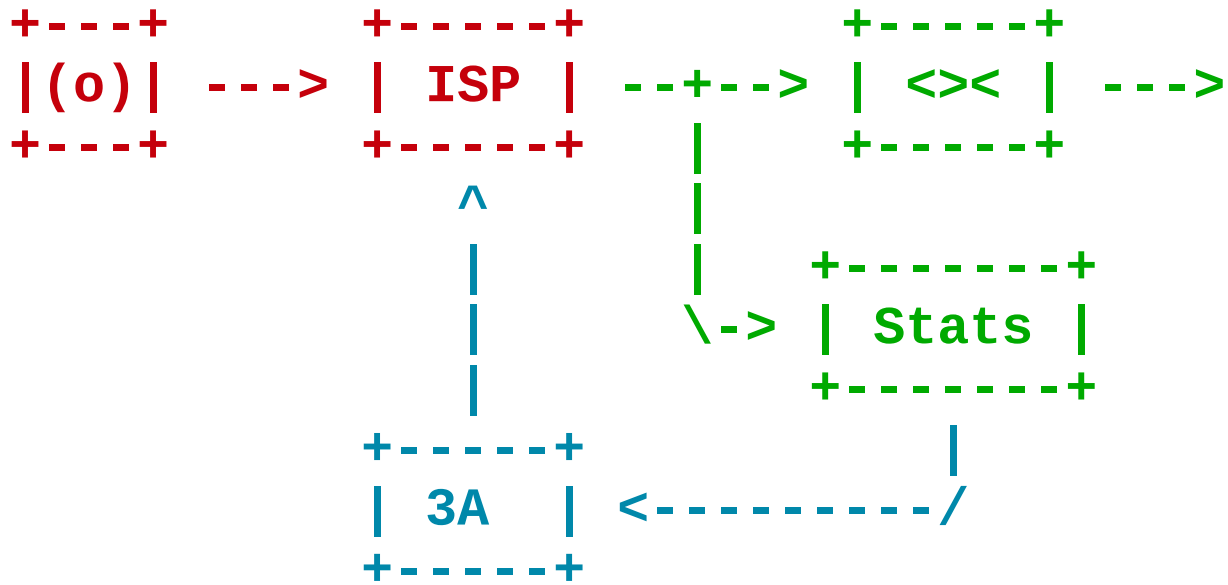

3A & Image Enhancement Algorithms

+-----+
| V4L2 App. |
+-----+

+-----+
| V4L2
API |
+-----+

+-----+
| libcamera |
+-----+

Adaptation



+-----+
| V4L2 App. |
+-----+

+-----+
| Android |
+-----+

+-----+
| V4L2
API |
+-----+

+-----+
| _____/ |
/ . . \
!
!

+-----+

+-----+
| libcamera |
+-----+

Adaptation



+ - / \ - +

| (o) | libcamera

+ - - - - +



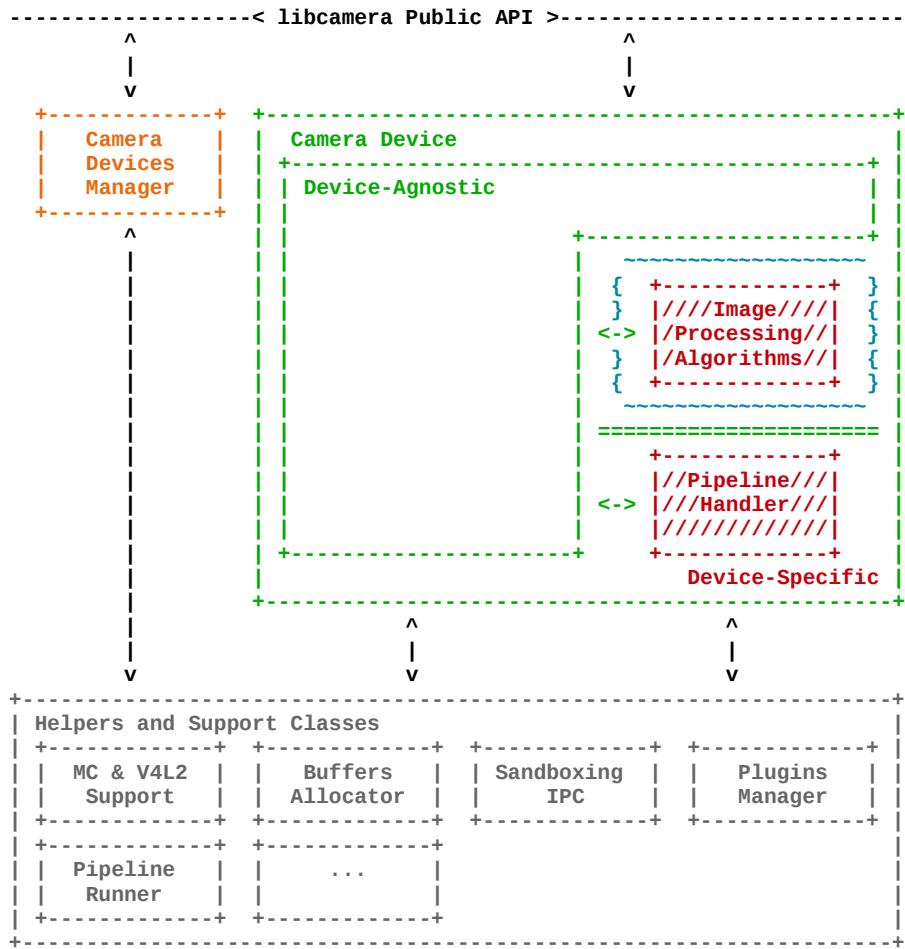

libcamera architecture

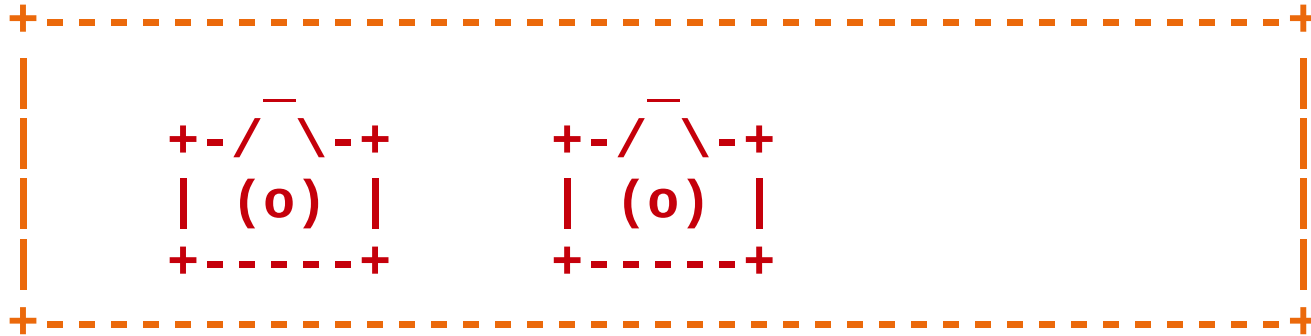

Camera Devices Manager



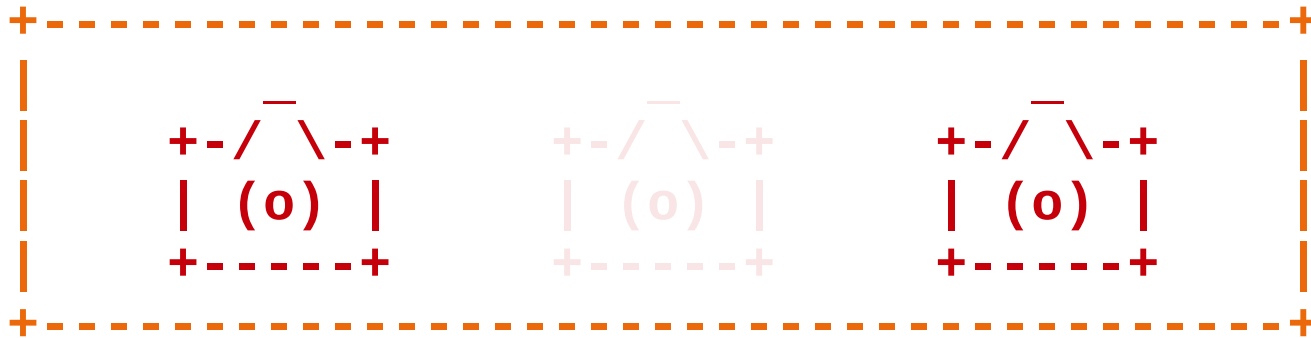

Camera Devices Manager

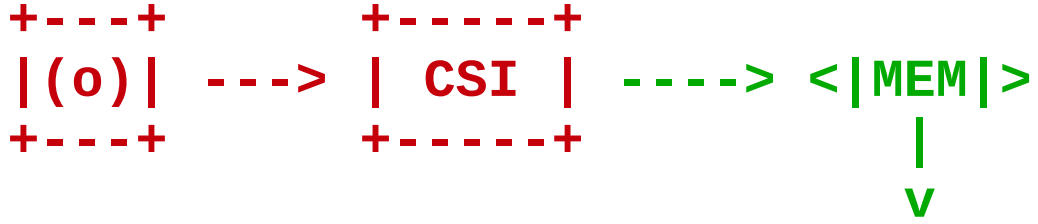

Pipeline Handler



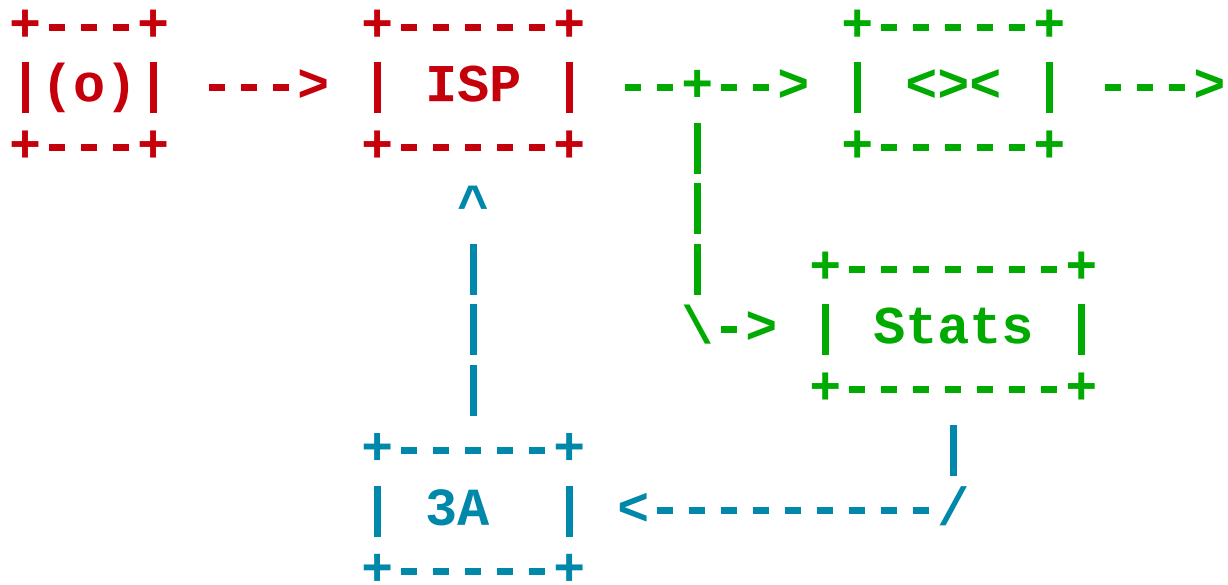

Image Processing Algorithms



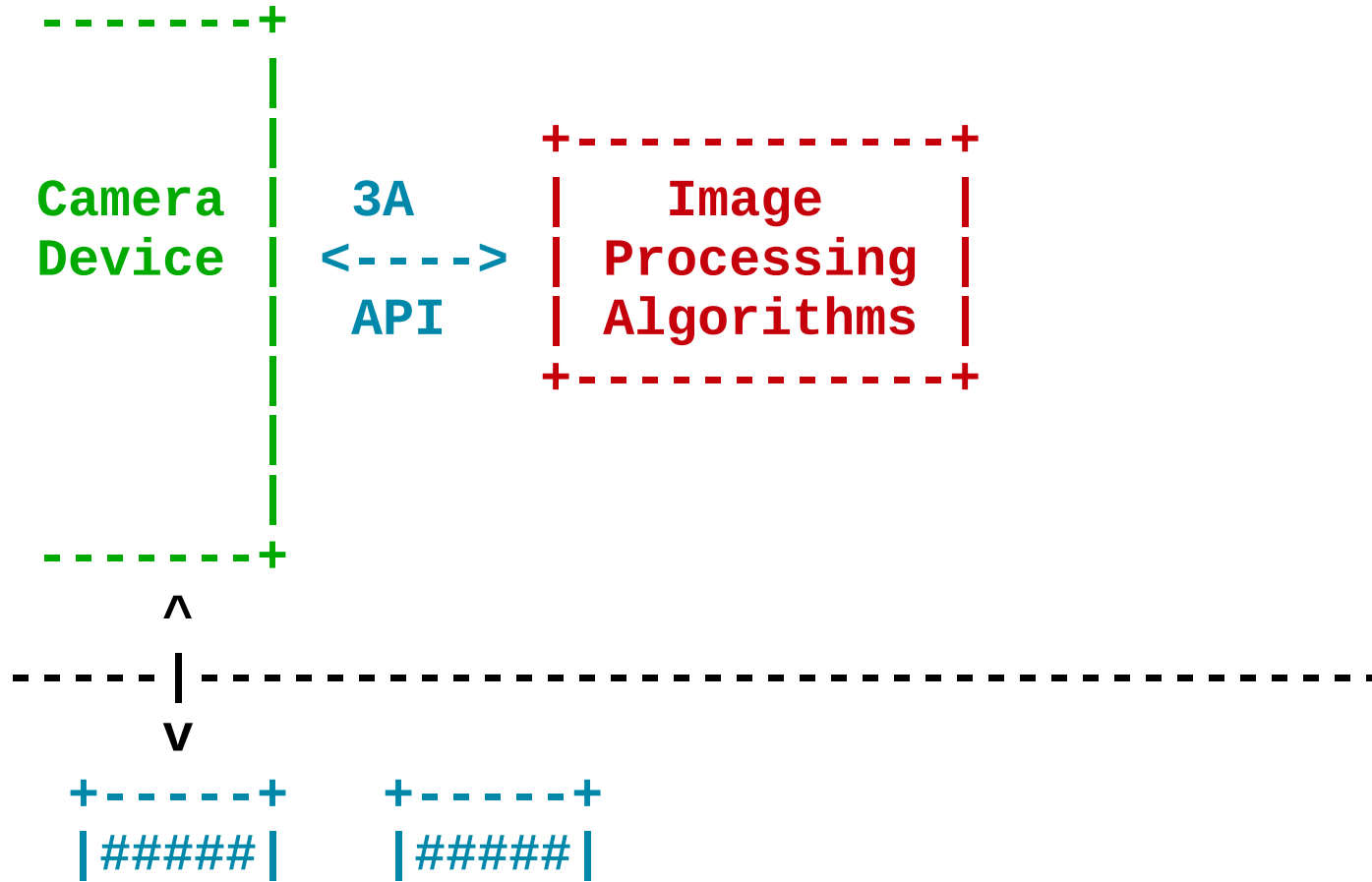

Image Processing Algorithms



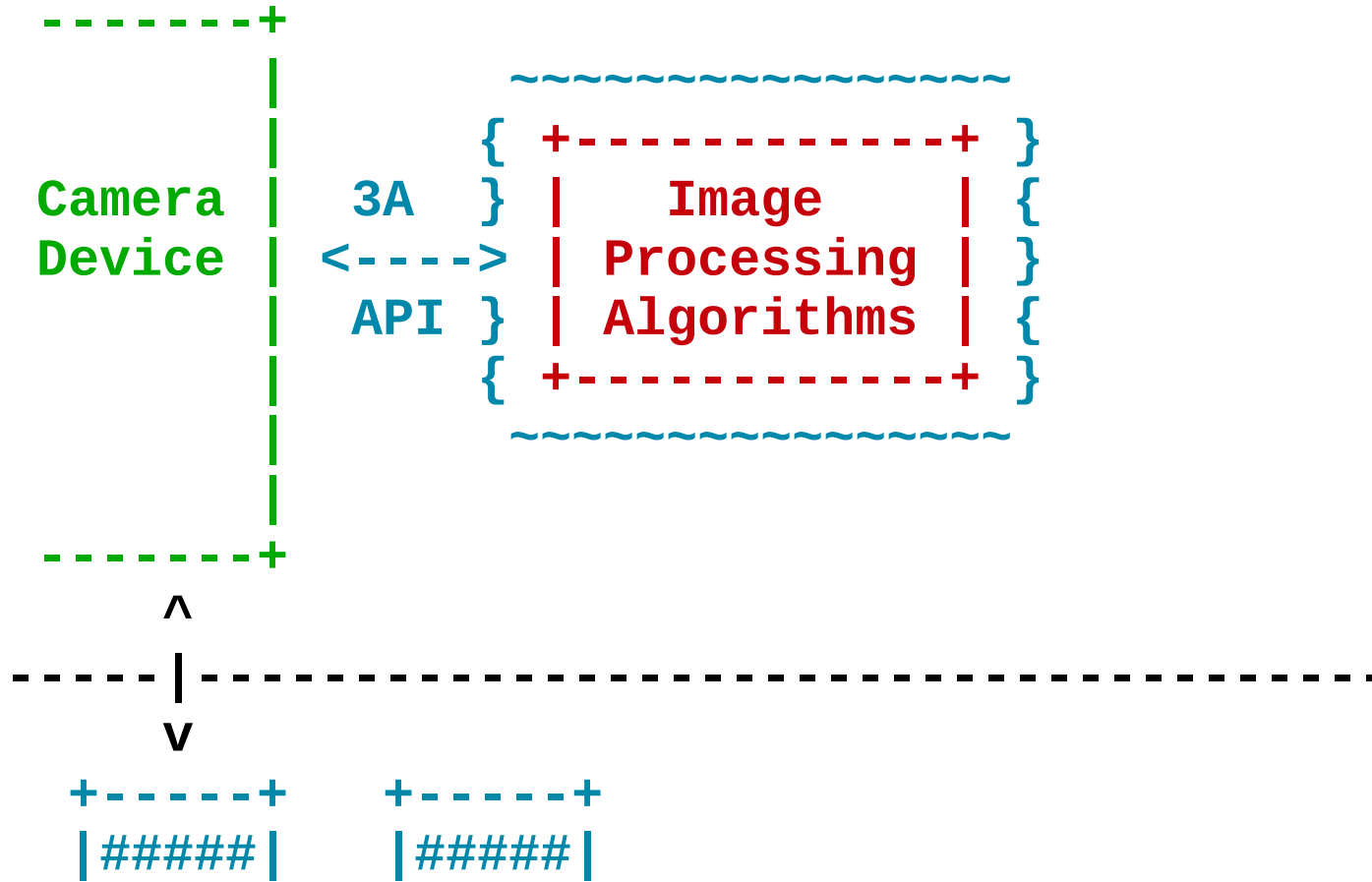

Image Processing Algorithms



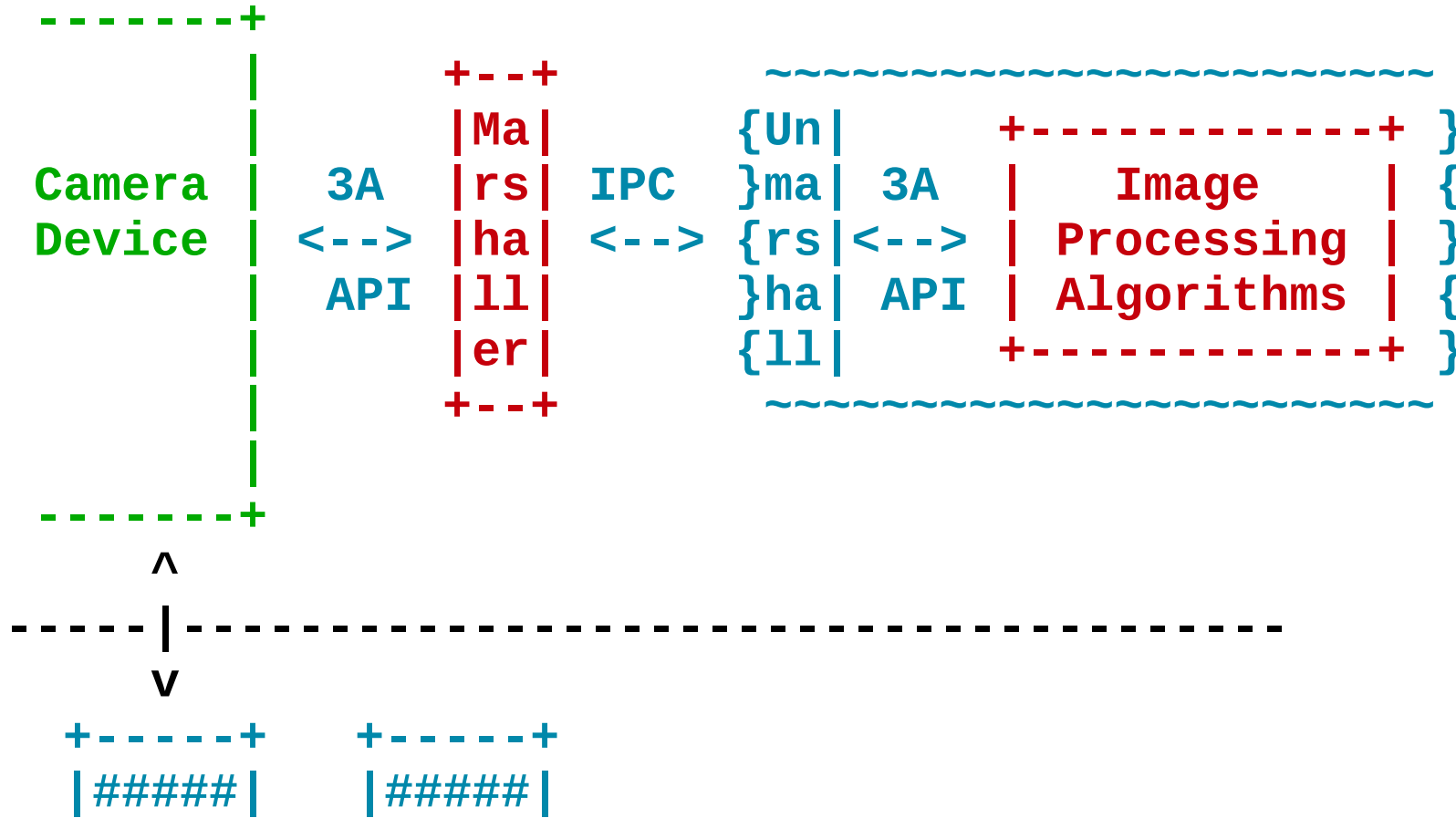
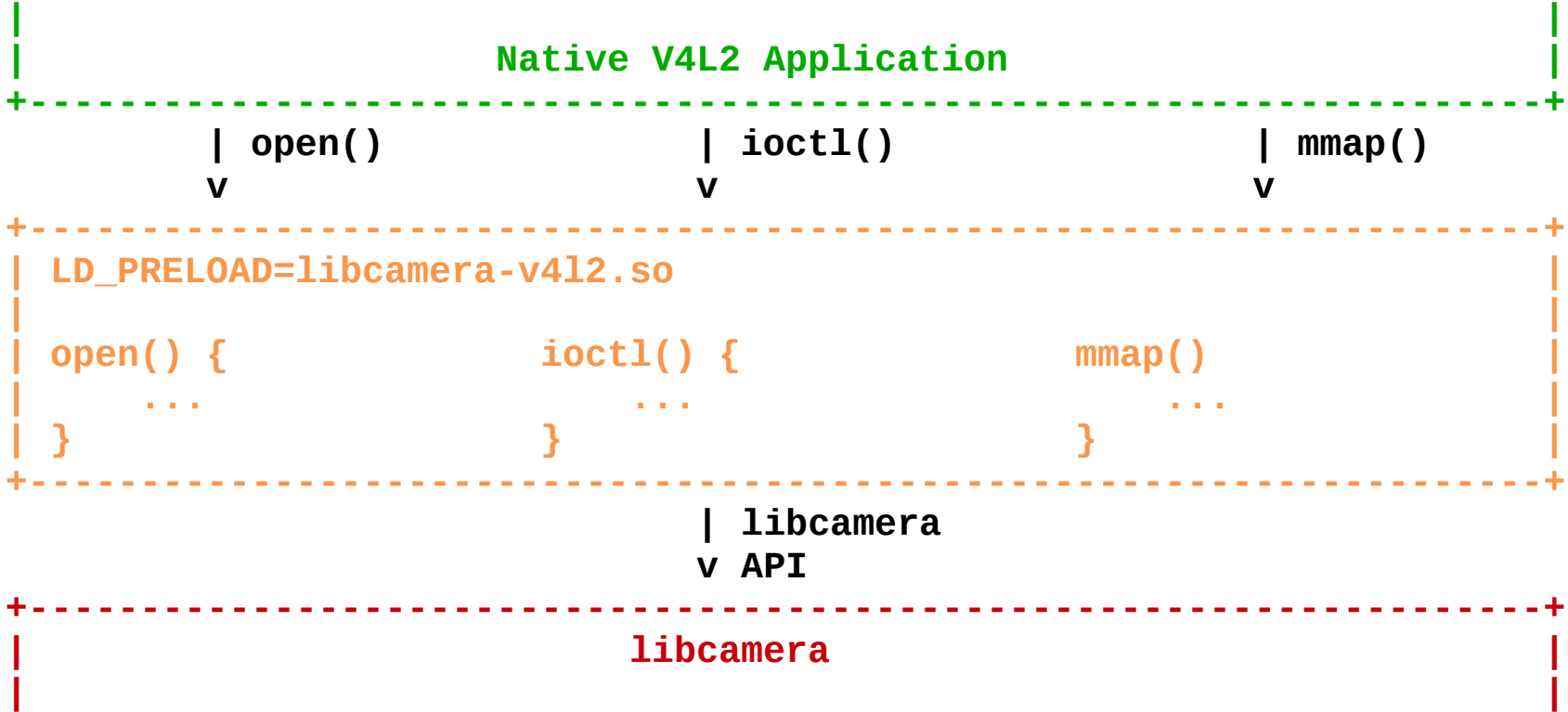

Image Processing Algorithms





V4L2 Compatibility

```

+-----+
| Android Camera Framework |
+-----+

```

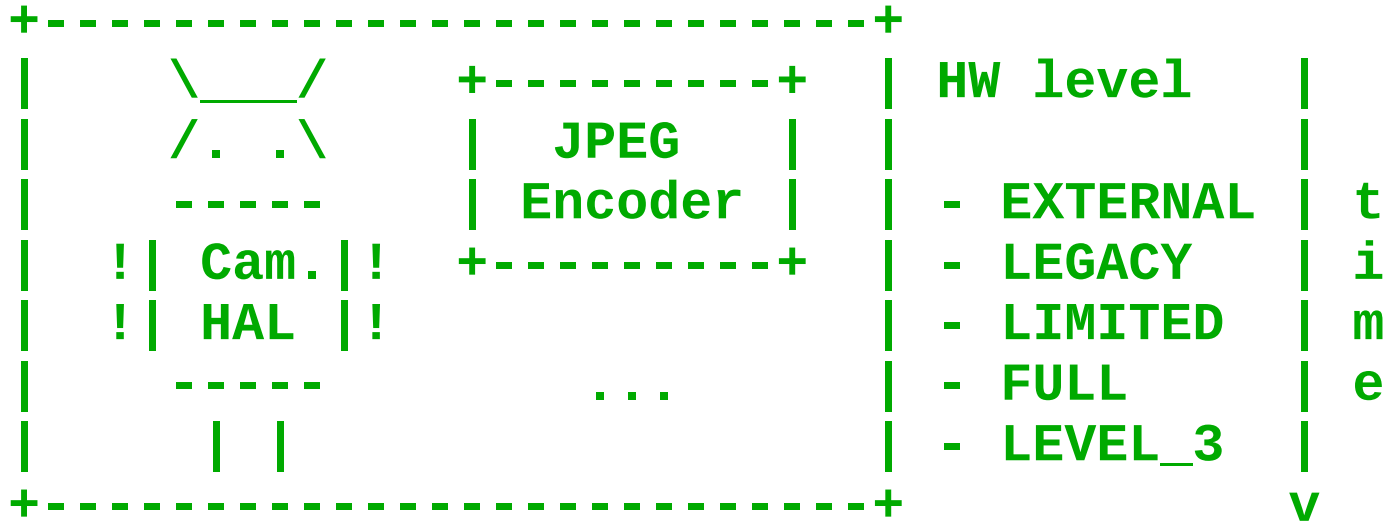

```

+-----+
| libcamera |
+-----+

```



Android Camera HAL

+ - / \ - +

| (o) | libcamera

+ - - - - +



Welcome!

libcamera is developed as a free software project and welcomes contributors. Whether you would like to help with coding, documentation, testing, proposing new features, or just discussing the project with the community, you can join our official public communication hannels, or simply check out the code.

Mailing List

We use a public mailing list as our main mean of communication. You can find subscription information and the messages archive on the libcamera-devel [list information](#) page.

IRC Channel

For informal and real time discussions, our IRC channel on Freenode is open to the public. Point your IRC client to [#libcamera](#) to say hello.

Source Code

libcamera is in early stages of development, no releases are available yet. The source code is available from the project's [git tree](#), hosted by [LinuxTV](#).

```
$ git clone git://linuxtv.org/libcamera.git
```

Please refer to the README.md file included in the sources for compilation, installation and usage instructions.

Contents

1. Mailing List
2. IRC Channel
3. Source Code



Contribute

?

!



libcamera-devel@lists.libcamera.org
irc://chat.freenode.net/#libcamera

laurent.pinchart@ideasonboard.com



Contact

Thank ye!

